









































# Renvooi

positie ventilatieventielen en pv panelen indicatief

	enkele schakelaar		loze leiding		vloerverwarming
	dubbele schakelaar		thermostaat		verdeler
	enkele wissel schakelaar		data aansluiting		elektrische designradiator
	wandcontactdoos enkel geaard		aansl. zonwering		rookmelder
	wandcontactdoos dubbel geaard, horizontaal		Co2 sensor		hemelwaterafvoer
	aardelektrode		aansluiting verdeler vloerverwarming		opstelplaats wasmachine/wasdroger
	aansluitpunt + 1 fase + nul + aarde		aansluiting wasmachine/wasdroger		warmtepomp
	plafondlichtpunt		elektrische radiator		draingoot
	bel		toevoerventielen ventilatie, indicatief		douche dorpel en scherm
	beldrukker		afvoerventielen ventilatie, indicatief		einde VG einde verblijfsgebied
	wandaansluiting verlichting, binnen		gevelpakket keramische gevelementen-spouw-isolatie-binnenblad		prv privacy scherm
	wandaansluiting verlichting, buiten		gevelement met vezelcementplaat bekleding (in garage)		kr.i. kruipluik
	warmtepomp		woningscheidende wand		
	warmteterugwinunit		GIBO wand		
	omvormer		tegelindelingen indicatief		

# Optiematrix

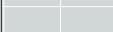
Gevelopties	Bouwnummer																
	01	02	03	04	05	06	07	08	09	10	11	12	13	14	15	16	17
1e. Uitbouw voorgevel 1e verdieping	X	O	O	O	X	X	O	O	O	O	X	X	O	O	O	O	X
1e. Alleen mogelijk i.c.m. uitbouw voorgevel: optie bloemkozijn	X	X	O	X	X	X	O	X	X	O	X	X	O	X	X	O	X
2e. Uitbouw voorgevel 2e verdieping	X	X	X	O	X	X	X	X	X	O	X	X	X	X	O	O	X
2e. Bloemkozijn voorgevel 2e verdieping	X	X	X	S	X	O	X	X	X	X	S	X	X	X	S	X	X
2e. Dakterras tpv 2e verdieping (alleen icm optie uitbouw 1e verdieping)	X	O	O	X	X	X	O	O	O	X	X	X	O	O	X	X	X
3e. Bloemkozijn voorgevel 3e verdieping	X	O	X	X	X	X	X	O	X	X	X	X	X	X	X	X	X
3e. Dakopbouw 3e verdieping	X	S	S	O	O	X	X	S	S	X	X	O	X	S	S	O	O

\*2e verdieping kan alleen uitgebreid samen met de 1e.

- X** = niet mogelijk voor dit bouwnummer
- O** = wel mogelijk voor dit bouwnummer
- S** = standaard



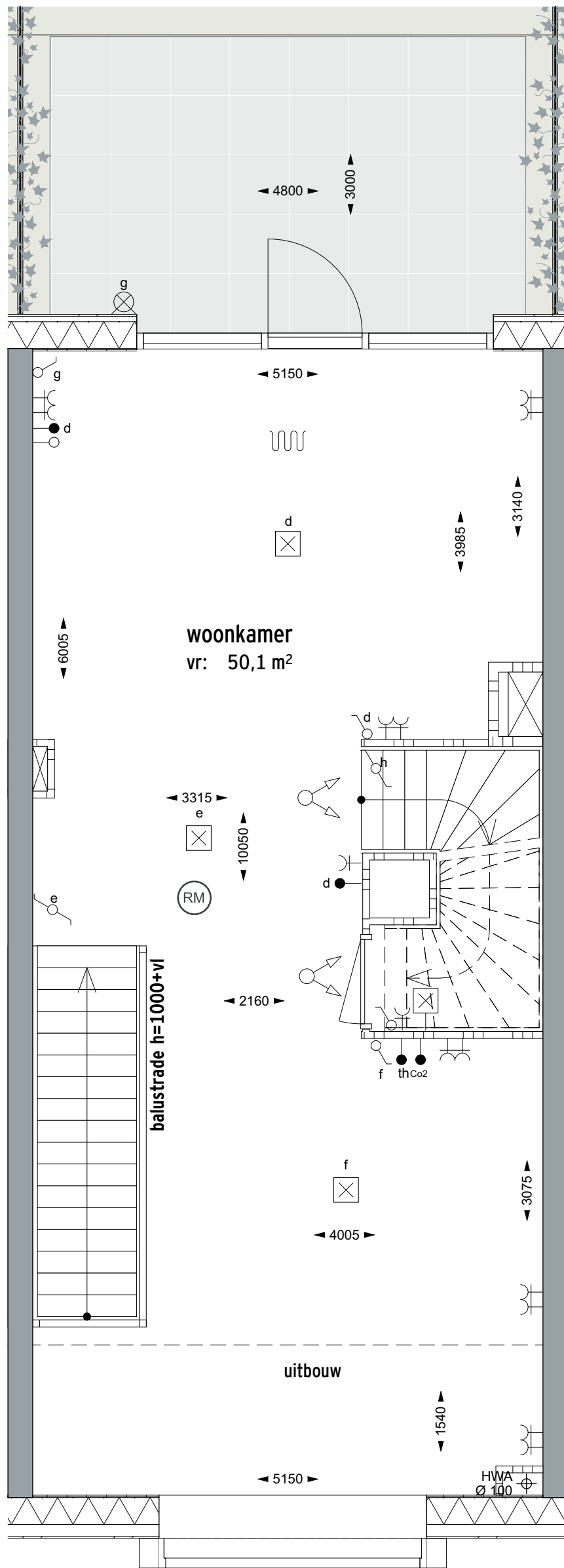

1e-B. Alleen mogelijk i.c.m. uitbouw voorgevel: optie bloemkozijn.

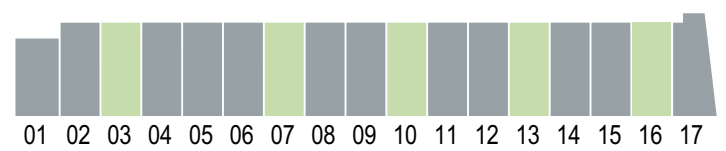

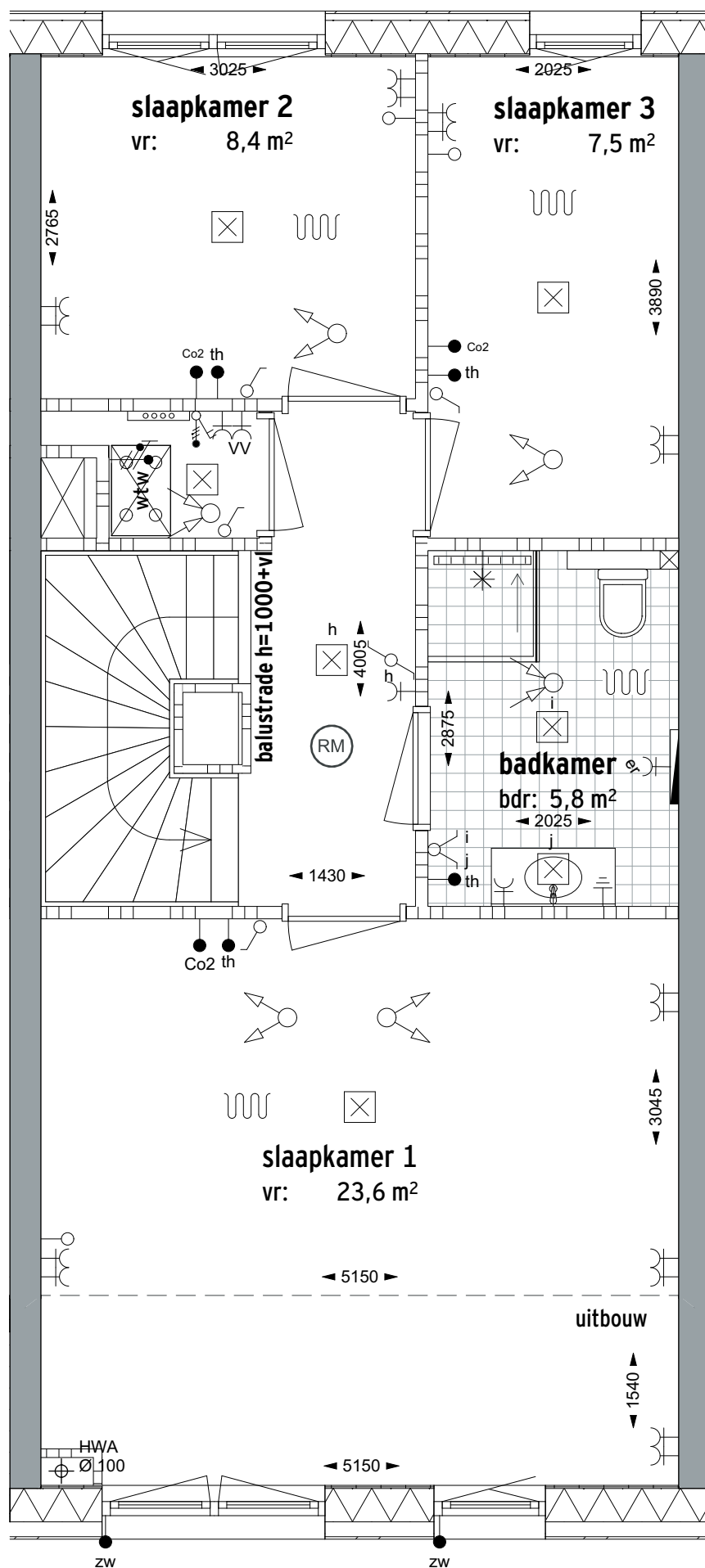

2e-A. Uitbouw voorgevel 2e verdieping.

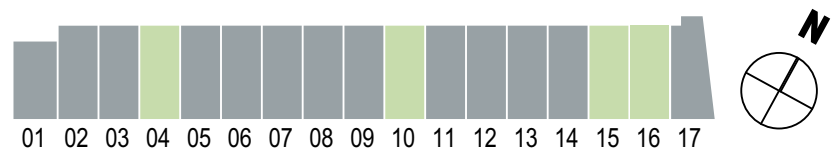

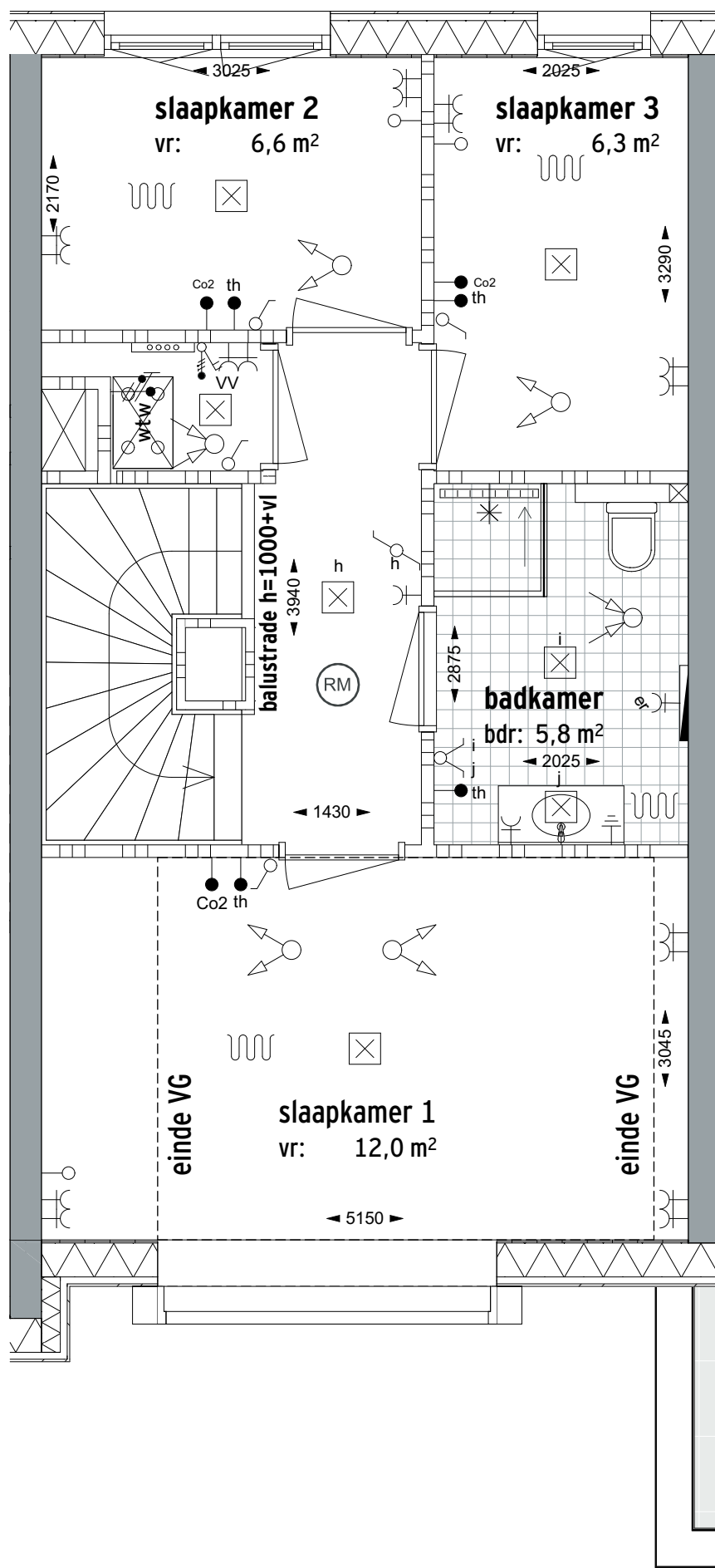

2e-C. Bloemkozijn voorgevel 2e verdieping.

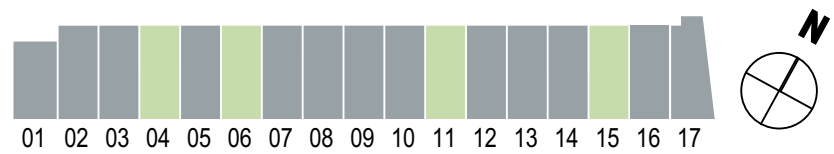

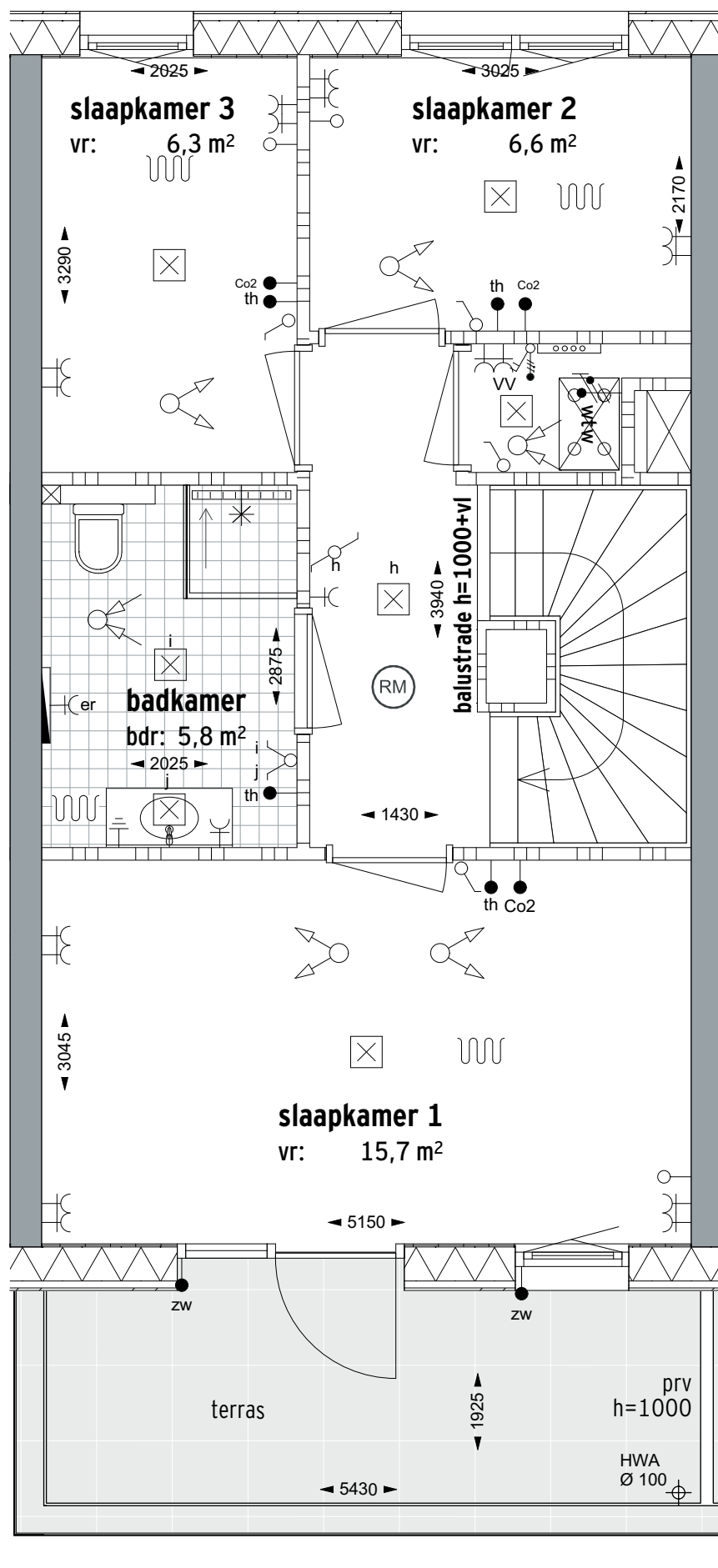

2e-D. Dakterras tpv 2e verdieping (alleen icm optie uitbouw 1e verdieping).

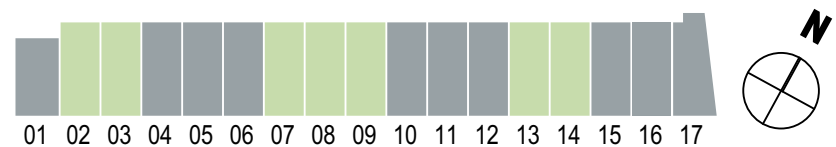

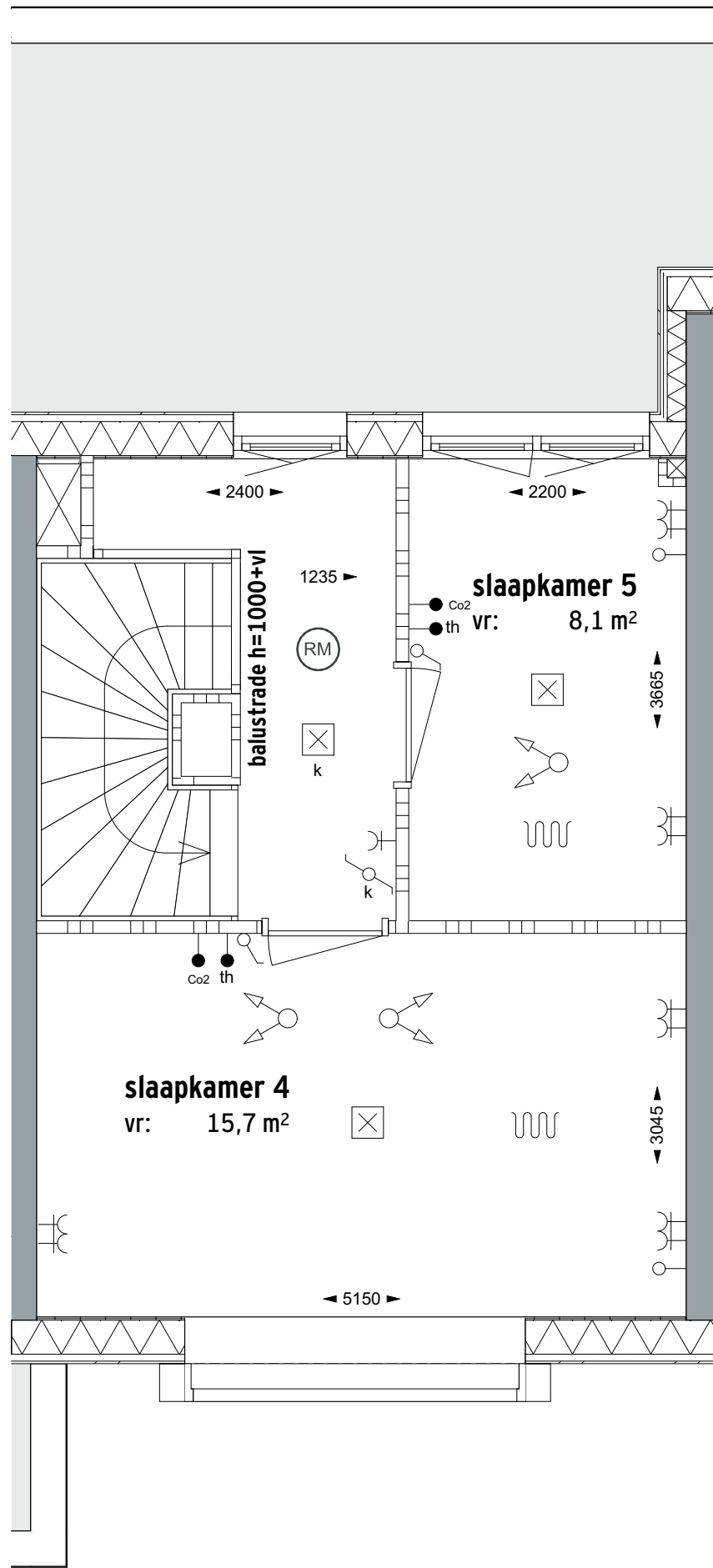

3e-A. Bloemkozijn voorgevel 3e verdieping.

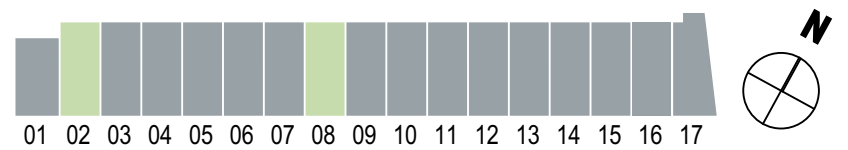



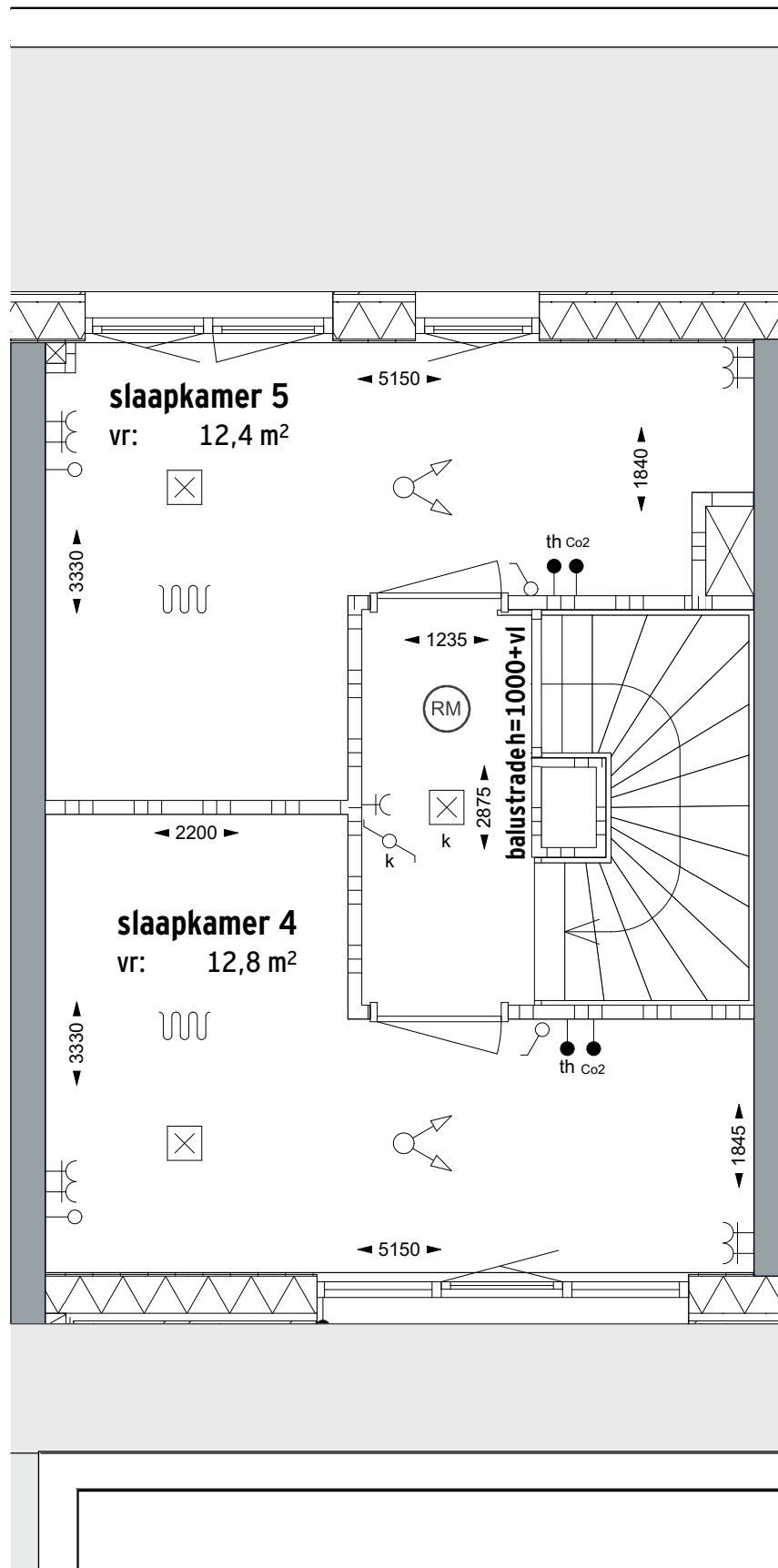

3e-B. Dakopbouw 3e verdieping.

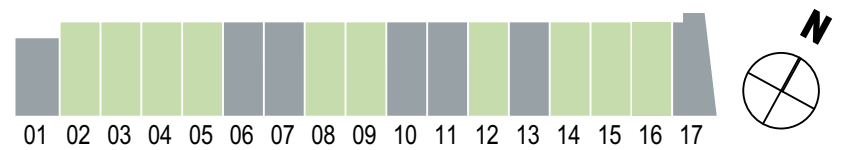

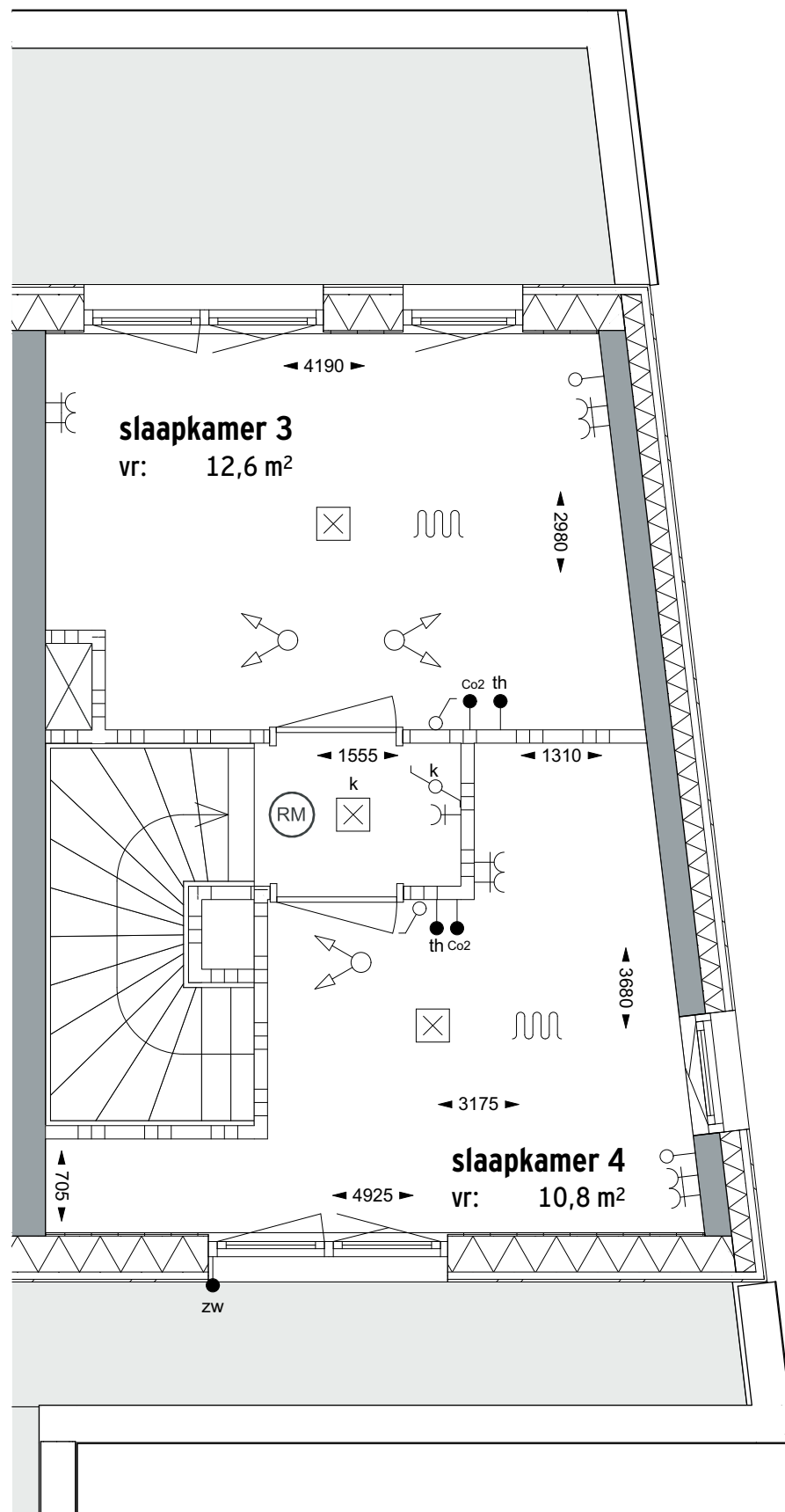

3e-C. Dakopbouw 3e verdieping. Bwnr 17.

